

# PRODUCT SPECIFICATION

Product Name	3316 SMD POWER INDUCTORS - OPEN TYPE	Page	1
TAMURA Part No.	TO3316-XXX□	Rev. No.	0

## 1. CONFIGURATION & DIMENSIONS :

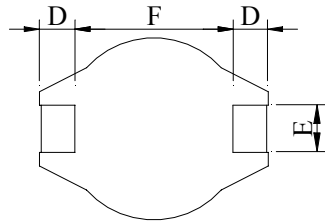
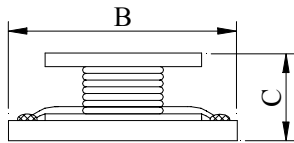
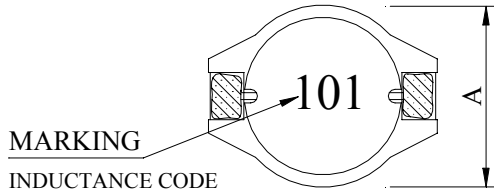

A :	10.0±0.2	m/m
B :	12.7±0.2	m/m
C :	5.0±0.3	m/m
D :	2.4±0.2	m/m
E :	2.2±0.2	m/m
F :	7.6±0.3	m/m
G :	7.3 REF.	m/m
H :	2.8 REF.	m/m
I :	3.0 REF.	m/m

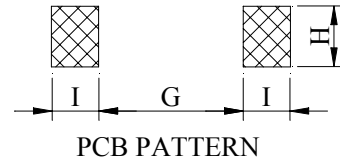

## 2. SCHEMATIC DIAGRAM :

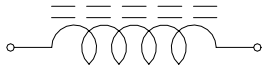

## 3. GENERAL SPECIFICATION :

- a) TEMP. RISE : 40°C TYP.
- b) RATED CURRENT : BASE ON TEMP. RISE &  $\Delta$  LOA=10% TYP.
- c) STORAGE TEMP. : -40°C ~ +125°C
- d) OPERATING TEMP. : -25°C ~ +105°C
- e) RESISTANCE TO SOLDER HEAT : 260°C FOR 10 SECS.

# PRODUCT SPECIFICATION

Product Name	3316 SMD POWER INDUCTORS - OPEN TYPE	Page	2
TAMURA Part No.	TO3316-XXX□	Rev. No.	0

## 4. ELECTRICAL CHARACTERISTICS :

TAMURA Part No.	INDUCTANCE ( $\mu$ H)	Q REF.	TEST FREQ. (HZ)		SRF (MHZ) TYP.	RDC (mOhm) MAX	IDC (A)
			L	Q			
TO3316-1R0M	1.0 $\pm$ 20%	50	100K		150.0	9	6.8
TO3316-1R5M	1.5 $\pm$ 20%	50	100K		100.0	10	6.4
TO3316-2R2M	2.2 $\pm$ 20%	45	100K		85.0	12	6.1
TO3316-3R3M	3.3 $\pm$ 20%	35	100K		60.0	15	5.4
TO3316-4R7M	4.7 $\pm$ 20%	35	100K		45.0	18	4.8
TO3316-6R8M	6.8 $\pm$ 20%	35	100K		35.0	27	4.4
TO3316-100M	10.0 $\pm$ 20%	30	100K		25.0	38	3.9
TO3316-150M	15.0 $\pm$ 20%	30	100K		20.0	46	3.1
TO3316-220M	22.0 $\pm$ 20%	25	100K		18.0	85	2.7
TO3316-330M	33.0 $\pm$ 20%	30	100K		14.0	100	2.1
TO3316-470M	47.0 $\pm$ 20%	20	100K		11.0	140	1.8
TO3316-680M	68.0 $\pm$ 20%	35	100K		10.0	200	1.5
TO3316-101M	100.0 $\pm$ 20%	40	100K		7.0	280	1.3
TO3316-151M	150.0 $\pm$ 20%	40	100K		6.5	400	1.0
TO3316-221M	220.0 $\pm$ 20%	40	100K		5.0	610	0.8
TO3316-331M	330.0 $\pm$ 20%	60	100K		4.0	1020	0.6
TO3316-471M	470.0 $\pm$ 20%	50	100K		3.0	1270	0.5
TO3316-681M	680.0 $\pm$ 20%	65	100K		2.5	2020	0.4
TO3316-102M	1000.0 $\pm$ 20%	60	100K		2.0	3000	0.3

# PRODUCT SPECIFICATION

duct Name	3316 SMD POWER INDUCTORS - OPEN TYPE	Page	3
MURA Part No.	TO3316-XXX□	Rev. No.	0

### RECOMMENDED SOLDERING CONDITIONS REFLOW SOLDERINGS

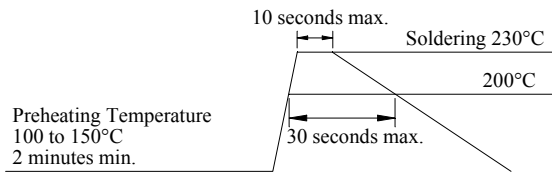

## PACKAGING INFORMATION :

### 1. CONFIGURATION :

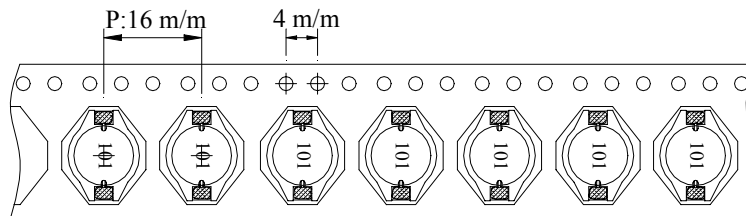
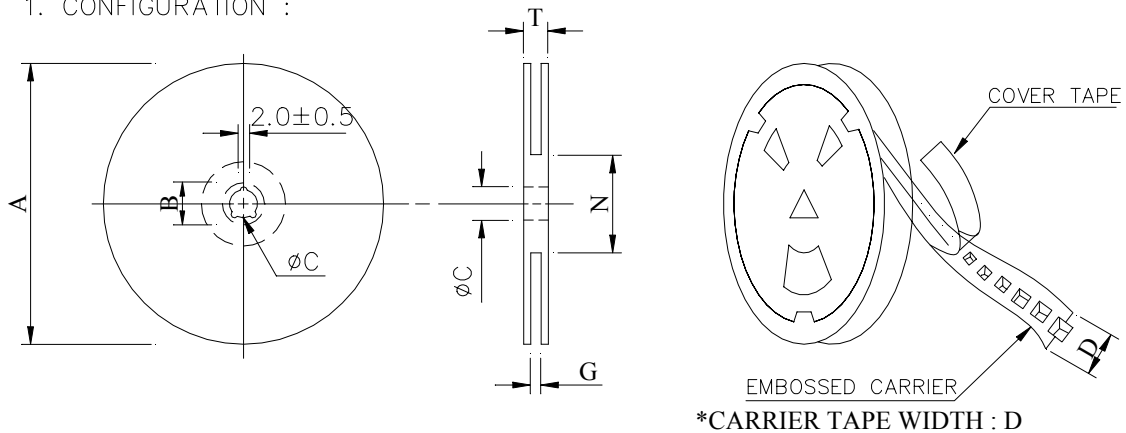

### 2. DIMENSIONS : (m/m)

STYLE	A	B	C	D	G	N	T
13 - 24	330	21±0.8	13±0.5	24	26 MAX	50 MIN	30.4

### 3. Q'TY & G.W. PER PACKAGE :

SERIES	INNER : REEL			OUTER : CARTON		
	Q'TY (PCS)	G.W. (gw)	STYLE	Q'TY (PCS)	G.W. (kg)	SIZE (cm)
T03316	500	1000	13 - 24	2000	5.5	40 x 40 x 24

# PRODUCT SPECIFICATION

Product Name	3316 SMD POWER INDUCTORS - OPEN TYPE	Page	4
TAMURA Part No.	TO3316-XXX□	Rev. No.	0

## 6. Part No. FORMAT :

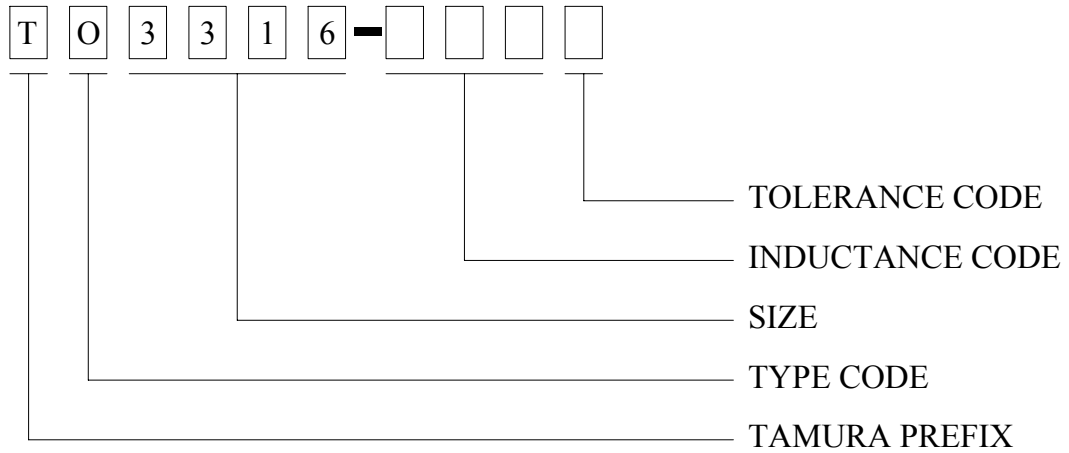

# PRODUCT SPECIFICATION

Product Name	3316 SMD POWER INDUCTORS - OPEN TYPE	Page	5
TAMURA Part No.	TO3316-XXX□	Rev. No.	0

## 7. RELIABILITY TEST :

TEST ITEM	SPECIFICATION	TEST CONDITION										
SOLDERABILITY	MORE THAN 90% OF THE TERMINAL ELECTRODE SHALL BE COVERED WITH FRESH SOLDER.	PREHEAT : 125±25°C FOR 60 SECONDS SOLDER : H63A ( EUTECTIC SOLDER ) SOLDER TEMP. : 230±5°C FLUX : ROSIN DIP TIME : 4±1 SECONDS										
THERMAL SHOCK TEST  ( TEMP. CYCLE )	INDUCTANCE SHALL NOT CHANGE MORE THAN ±20%	<table style="width: 100%; border: none;"> <tr> <td style="width: 60%;">ROOM TEMP. —————→</td> <td style="width: 40%; text-align: center;">-25±2°C</td> </tr> <tr> <td>15 MINUTES</td> <td style="text-align: center;">30 MINUTES</td> </tr> <tr> <td colspan="2"> </td> </tr> <tr> <td>ROOM TEMP. —————→</td> <td style="text-align: center;">85±2°C</td> </tr> <tr> <td>15 MINUTES</td> <td style="text-align: center;">30 MINUTES</td> </tr> </table> TOTAL : 50 CYCLES	ROOM TEMP. —————→	-25±2°C	15 MINUTES	30 MINUTES			ROOM TEMP. —————→	85±2°C	15 MINUTES	30 MINUTES
ROOM TEMP. —————→	-25±2°C											
15 MINUTES	30 MINUTES											
ROOM TEMP. —————→	85±2°C											
15 MINUTES	30 MINUTES											
HUMIDITY RESISTANCE TEST		TEMPERATURE : 40±2°C HUMIDITY : 90 ~ 95% APPLIED CURRENT : PER SPEC. TIME : 500 HOURS										
HIGH TEMP. RESISTANCE TEST		TEMPERATURE : 85±2°C APPLIED CURRENT : PER SPEC. TIME : 500 HOURS										